

Series
VENTS KSA



Centrifugal fans in heat- and sound-insulated casing with the air capacity up to **2140 m³/h**

■ **Applications**

KSA fan design enables their application in supply and exhaust ventilation systems for the premises with high noise level requirements. Suitable for connection with Ø 100, 125, 150, 160, 200, 250 and 315 mm round ducts.

■ **Design**

The fan casing is made of aluzinc. Heat- and sound-insulating layer is made of polystyrene foam.

■ **Motor**

The impeller with forward curved blades made of gal-

vanized steel is powered by 2- or 4-pole external rotor asynchronous motor. The motor is equipped with the ball bearings for long service life. For precise features, safe operation and low noise, each impeller is dynamically balanced while assembly. Motor protection rating IP 44.

■ **Speed control**

Smooth or step speed control with a thyristor or autotransformer speed controller. Several fans may be connected to one speed controller provided that the total power and operating current do not exceed the rated speed controller parameters.

■ **Mounting**

Connection pipes have round section. The basic fan model is supplied with a power cord without plug. The power cord and C14 (KSA..R) plug are available on separate order. Electric connection and mounting shall be performed in compliance with the operation manual and wiring diagram.

■ **The fan with electronic temperature and control module (U option).**

The ideal solution for ventilation of the premises requiring permanent temperature control, i.e. greenhouses. The fan with the electronic temperature and speed control module provides automatic control of the motor speed (air capacity) depending on air temperature in the air duct or in the room.

The fan front panel has the following control knobs:

- speed control knob for setting the motor speed;
- thermostat control knob for setting the temperature set point;
- thermostat indicator light.

The fan is available in two modifications:

- with the temperature sensor integrated inside the fan air duct (U/U1 option);

- with the external temperature sensor fixed on the cable, 4 m long (Un / U1n).

■ **Control logic of the fan with the electronic temperature and speed control module.**

Set the desired air temperature (thermostat set point) by turning the thermostat control knob. Set the required minimum impeller speed (air flow) by turning the speed control knob. The motor switches to maximum speed (maximum air flow) as the temperature reaches and exceeds the set temperature set point. The motor switches to the preset lower speed as the temperature drops down below the temperature set point. To avoid frequent motor speed switches when the air temperature in the duct is equal to the set temperature point, the speed switch delay is activated. There are two switch delay patterns for various cases:

1. The temperature sensor-based switch delay (U option): the motor switches to higher speed as the air temperature exceeds 2 °C above the set thermostat set point. The motor reverts to the preset lower speed as the air temperature drops below the thermostat set point. This pattern is used to keep air temperature to within 2 °C. In this case the motor speed switches are rare.
2. The timer-based switch delay (U1 option): as the air temperature exceeds the set thermostat set point, the motor switches to higher speed and the switch delay timer is activated for 5 min. The motor reverts to lower speed as the air temperature drops down below the thermostat set point and only after 5 minutes timer countdown.

This pattern is used for exact air temperature control. The speed switches for the fan with U1 option are more frequent as compared to the operating logic of the fan with U option, however the minimum operating cycle at one speed is 5 minutes.

Designation key: _____

Series	Spigot diameter	Motor		Options
		Polarity	Phase	
VENTS KSA	100; 125; 150; 160; 200; 250; 315	2, 4	E – single phase	<p>R – power cord with IEC C14 electric plug.</p> <p>U – speed controller with electronic thermostat and temperature sensor integrated into the air duct. Equipped with power cord and IEC C14 electric plug. Temperature-based operation logic.</p> <p>Un – speed controller with electronic thermostat and external temperature sensor fixed on 4 m cable. Equipped with power cord and IEC C14 electric plug. Temperature-based operation logic.</p> <p>U1 – speed controller with electronic thermostat and temperature sensor integrated into the air duct. Equipped with power cord and IEC C14 electric plug. Timer-based operation logic.</p> <p>U1n – speed controller with electronic thermostat and external temperature sensor fixed on 4 m cable. Equipped with power cord and IEC C14 electric plug. Timer-based operation logic.</p>

Accessories



page 378 page 386 page 388 page 392 page 406 page 442 page 446 page 461 page 462 page 476 page 477 page 480

Technical data:

	KSA 100-2E	KSA 125-2E	KSA 150-2E
Voltage [V / 50 Hz]	230	230	230
Power [W]	115	120	260
Current [A]	0.51	0.52	1.16
Max. air capacity [m ³ /h]	400	530	730
RPM [min ⁻¹]	2650	2650	2600
Noise level at 3 m [dBA]	36.1	38.3	39.4
Transported air temperature [°C]	-25 +40	-25 +40	-25 +40
SEC class	C	C	C
Protection rating	IPX4	IPX4	IPX4

Technical data:

	KSA 160-2E	KSA 200-4E	KSA 250-4E	KSA 315-4E
Voltage [V / 50 Hz]	230	230	230	230
Power [W]	260	110	395	570
Current [A]	1.16	0.45	1.98	2.48
Max. air capacity [m ³ /h]	730	850	1500	2140
RPM [min ⁻¹]	2600	1300	1330	1325
Noise level at 3 m [dBA]	37.9	29.1	35.5	43.7
Transported air temperature [°C]	-25 +40	-25 +40	-25 +40	-40 +55
SEC class	C	B	-	-
Protection rating	IPX4	IPX4	IPX4	IPX4

* The EC norm 1254/2014 does not apply if maximum air capacity is >1000 m³/h

Fan overall dimensions:

Type	Dimensions [mm]					Weight [kg]
	∅D	B	H	L	P	
KSA 100-2E	99	184	308	310	48	4.22
KSA 125-2E	123	204	308	310	48	4.57
KSA 150-2E	148	231	343	358	48	6.28
KSA 160-2E	158	231	343	358	48	6.28
KSA 200-4E	198	282	408	445	48	8.25
KSA 250-4E	248	330	500	525	48	10.50
KSA 315-4E	314	392	495	535	48	17.0

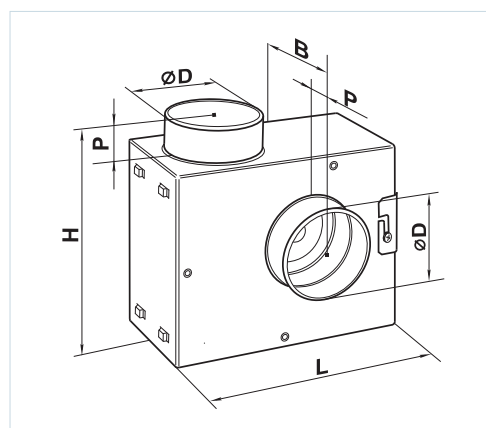

VENTS KSA

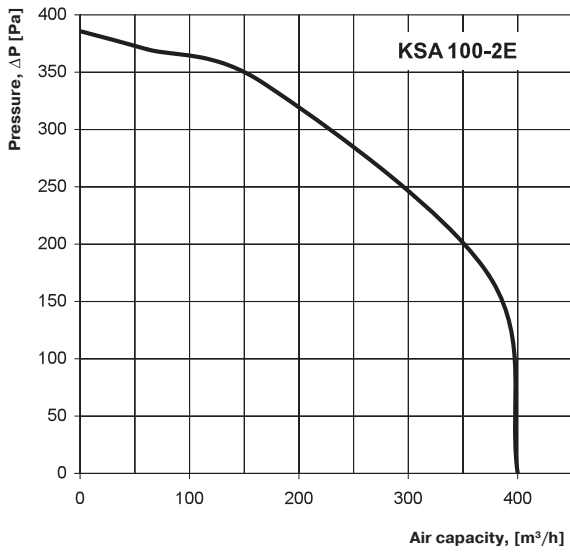

Sound-power level	Hz	Octave-frequency band [Hz]								
		Gen	63	125	250	500	1000	2000	4000	8000
L_{WA} to inlet	dBA	47	44	41	42	37	35	35	30	29
L_{WA} to outlet	dBA	50	45	41	41	37	35	31	30	28
L_{WA} to environment	dBA	43	39	36	37	31	30	28	25	22

VENTS KSA

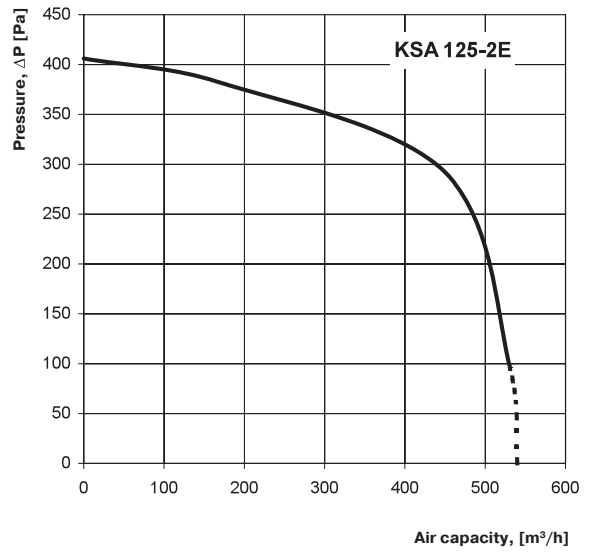

Sound-power level	Hz	Octave-frequency band [Hz]								
		Gen	63	125	250	500	1000	2000	4000	8000
L_{WA} to inlet	dBA	48	45	44	46	37	39	33	30	25
L_{WA} to outlet	dBA	50	45	43	47	39	39	33	29	27
L_{WA} to environment	dBA	45	40	39	41	34	33	27	23	22

VENTS KSA

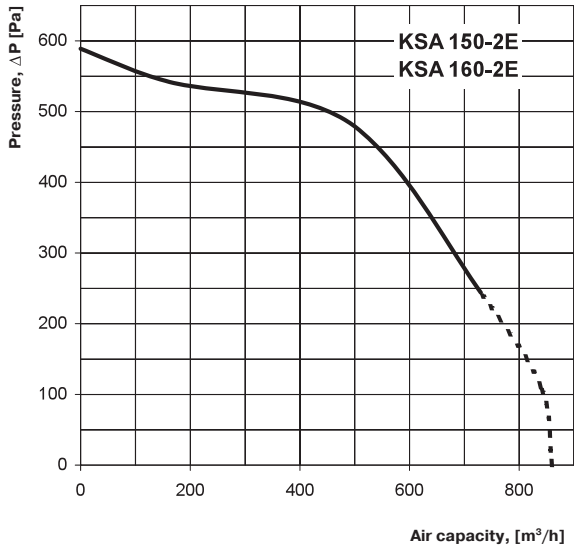

Sound-power level	Hz	Octave-frequency band [Hz]								
		Gen	63	125	250	500	1000	2000	4000	8000
L_{WA} to inlet	dBA	55	42	52	50	40	35	28	25	21
L_{WA} to outlet	dBA	55	43	51	48	40	34	29	23	23
L_{WA} to environment	dBA	50	39	48	44	35	30	25	20	17

Sound-power level	Hz	Octave-frequency band [Hz]								
		Gen	63	125	250	500	1000	2000	4000	8000
L_{WA} to inlet	dBA	56	44	51	48	38	33	29	24	22
L_{WA} to outlet	dBA	54	42	51	50	37	31	30	25	25
L_{WA} to environment	dBA	49	37	47	43	34	28	25	20	18

VENTS KSA

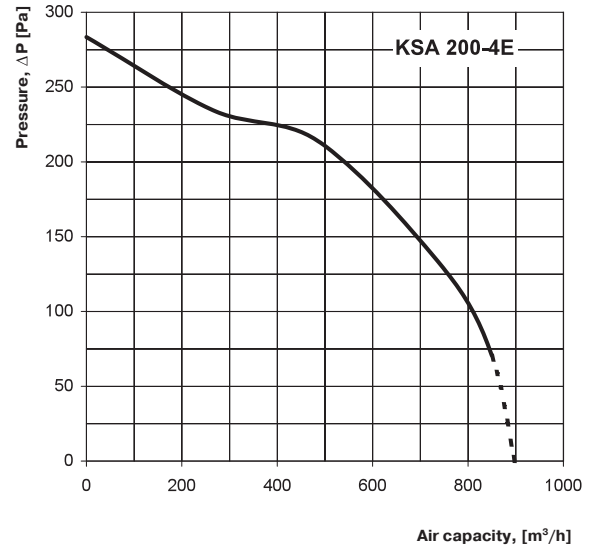

Sound-power level	Hz	Octave-frequency band [Hz]								
		Gen	63	125	250	500	1000	2000	4000	8000
L_{WA} to inlet	dBA	43	39	38	38	31	29	20	17	14
L_{WA} to outlet	dBA	43	36	38	34	34	27	23	18	18
L_{WA} to environment	dBA	38	33	35	31	27	22	16	13	11

VENTS KSA

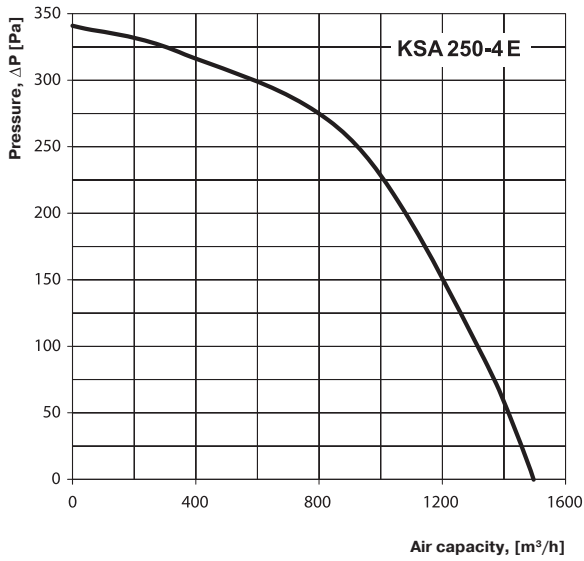

Sound-power level	Hz	Octave-frequency band [Hz]								
		Gen	63	125	250	500	1000	2000	4000	8000
L _{WA} to inlet	dBA	44	41	43	40	32	24	27	24	21
L _{WA} to outlet	dBA	46	41	45	38	32	26	29	22	18
L _{WA} to environment	dBA	41	35	38	33	27	21	24	18	15

VENTS KSA

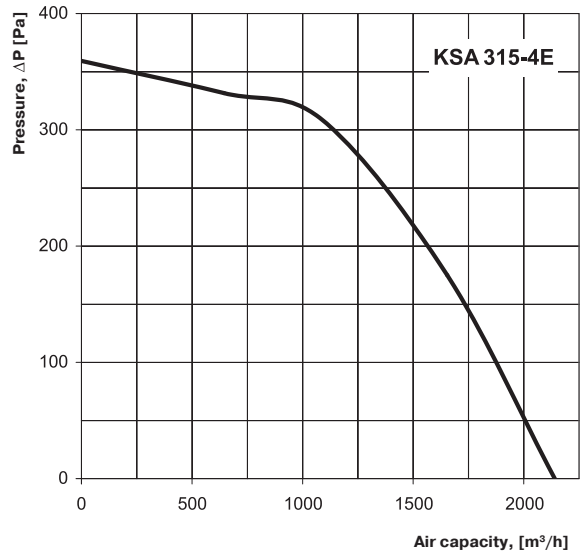

Sound-power level	Hz	Octave-frequency band [Hz]								
		Gen	63	125	250	500	1000	2000	4000	8000
L _{WA} to inlet	dBA	45	41	42	39	29	25	25	27	25
L _{WA} to outlet	dBA	48	43	46	40	35	26	30	20	19
L _{WA} to environment	dBA	44	36	39	31	25	22	25	18	17

FAN SERIES VENTS KSA

